

MODEL/YEAR MODÈLE /ANNÉE	DATE OF ISSUE DATE EN VIGUEUR	BULLETIN NUMBER NUMÉRO DU BULLETIN
2011 Odyssey	Dec. 9, 2013	BRN-13-3

Body Repair News

2011 Odyssey: New Model Body Repair Information

DISCLAIMER: This publication contains a summary of new body and vehicle technology that may affect collision and other body repairs. Always refer to the appropriate service and body repair manuals for complete repair information. A subscription may be purchased at: techinfo.honda.com

TABLE OF CONTENTS

New Model Body Technology	Page 2
Body Repair Information	Page 4
Welding Precautions and Information	Page 5
Airbag System Components and Repairs	Page 7
Electrical Repair Information	Page 9

OVERVIEW OF BODY FEATURES

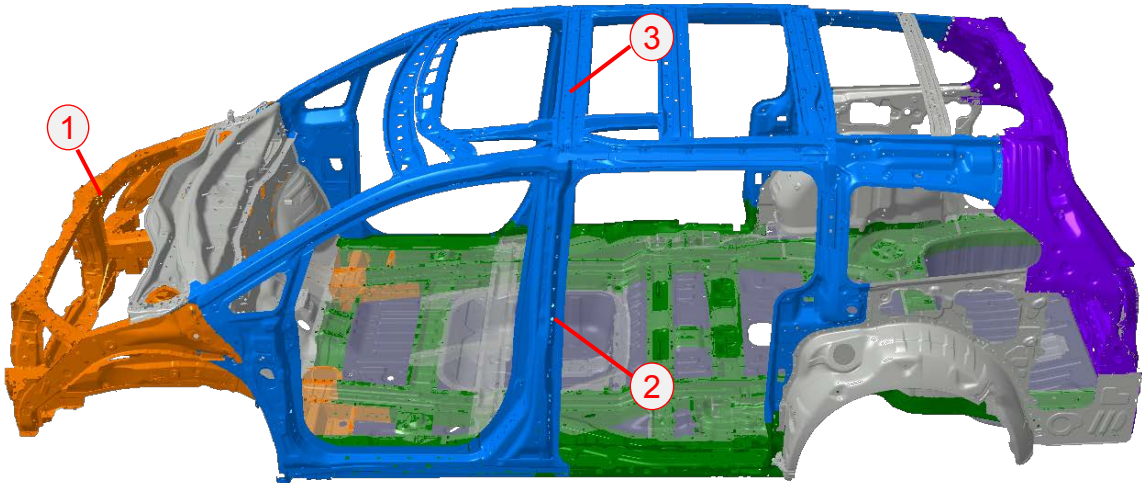

2011-13 models have these body features:

1. Advanced Compatibility Engineering™ (ACE™) body structure.
2. Extensive use of high tensile strength steel (59%), including 7% in grades 780, 980, and 1,500 MPa.
3. Reinforced roof structure for improved rollover protection.

For the 2014 model year, a minor model change (MMC) added or upgraded these body features:

1. Next-Generation Advanced Compatibility Engineering™ (ACE™) body structure.
2. Significant increase in the use of ultra high tensile strength steel over 2011-13 models, including 40 parts in grade 980 and 17 parts in grade 1,500 MPa. These new parts improve frontal crash energy management through a wider range of offset and oblique collision modes.

NOTE: The hood & front fenders are constructed of aluminum beginning with the 2014 model year.

New Model Body Technology

BODY CONSTRUCTION AND HIGH STRENGTH STEEL CONTENT

- Steel parts are color-coded based on their tensile strength in megapascals (MPa).
- High strength steel is defined as any steel with a tensile strength of 340 MPa or higher.
- Steel repair and welding procedures vary depending on the tensile strength of the parts involved.

NOTE: These illustrations are for general reference only. Some body parts are constructed from multiple layers of different tensile strength steels. Always refer to the body repair manual body construction section for specific steel tensile strength information.

2011-13 Body Construction

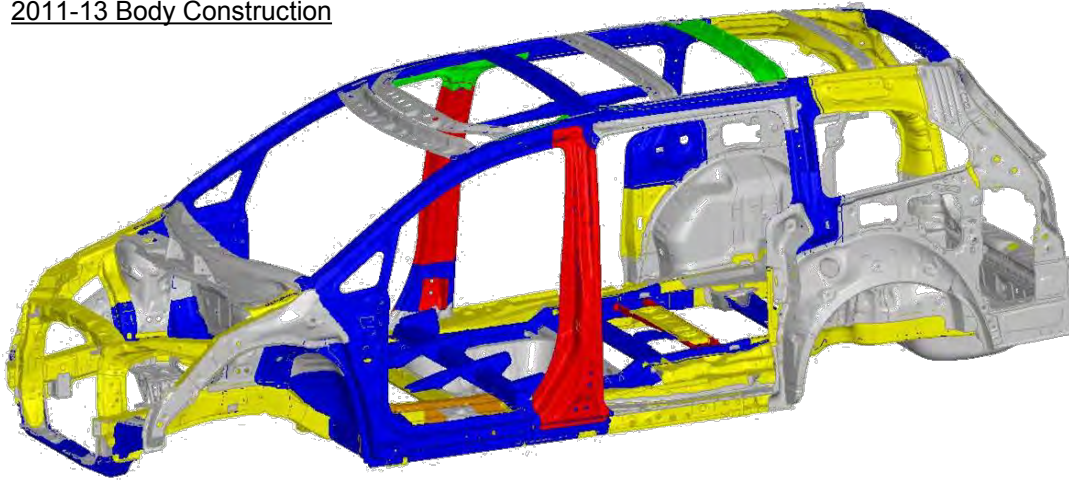

270 MPa

340 MPa

440 MPa

590 MPa

780 MPa

980 MPa

1,500 MPa

Steel Tensile
Strength Legend

2014 Body Construction

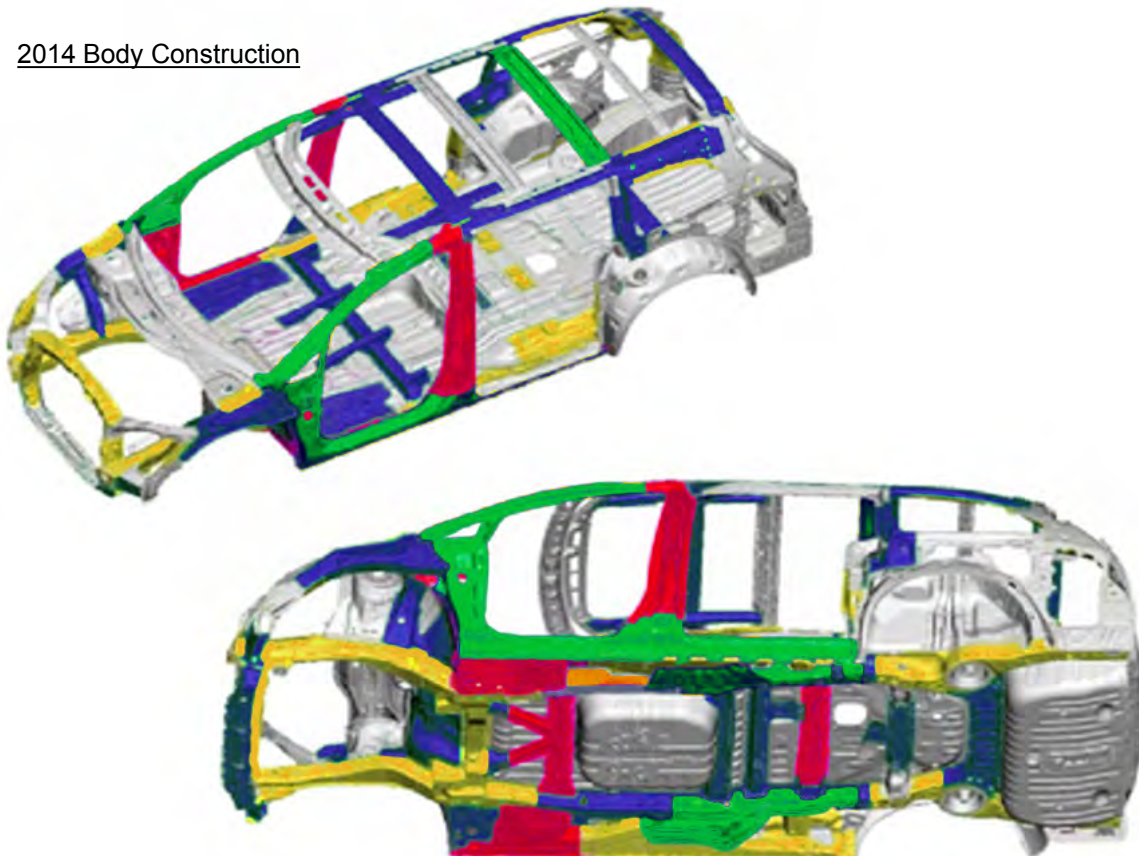

1,500 MPa (HOT STAMP) STEEL LOCATIONS

1,500 MPa steel is stronger than ordinary steel, so it can help protect vehicle occupants while reducing overall vehicle weight to improve fuel efficiency.

The numbered parts in the diagram below are constructed of 1,500 MPa steel:

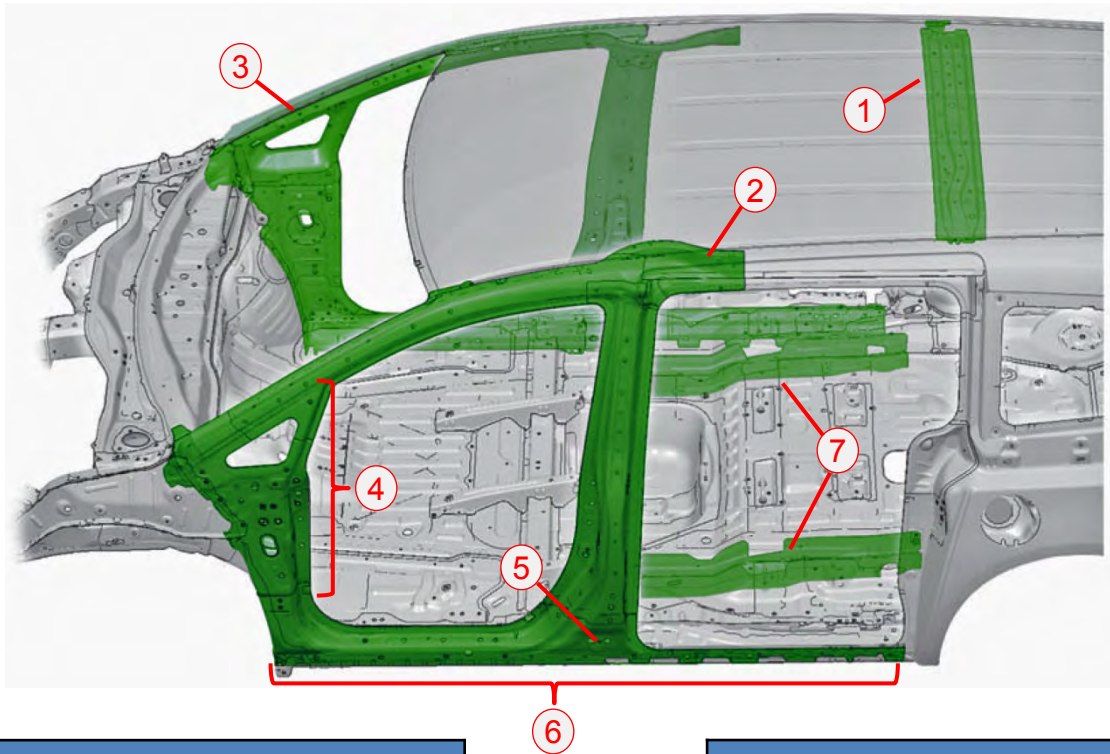

2011 - 13 Models	
1	Roof Arch "D"
2	Roof Side Front Rail

2014 Models	
1	Roof Arch "D"
2	Roof Side Front Rail
3	Front Inner Upper Pillar
4	Front Pillar Upper & Lower Stiffener
5	Center Pillar Stiffener
6	Side Sill Reinforcement & Extension
7	L&R Floor Frame Reinforcements

LIFTING AND TOWING PRECAUTIONS

- Flat bed towing equipment is the preferred method to transport this vehicle.
- Front wheel lift towing equipment may also be used to tow this vehicle.

For more information, refer to "Emergency Towing" in the owner's manual.

- Lift or jack only at the specified points to avoid damaging the vehicle.
- Do not lift or tow this vehicle by its bumpers, or serious damage will result.

For more information, refer to "Lift and Support Points" in the service or body repair manual.



Body Repair Information

NOTE: The following content is intended only to highlight new/special concerns. No body repairs should be attempted without first referencing the appropriate body repair manual for complete information.

USE OF HEAT DURING BODY STRAIGHTENING AND REPAIR

When you are doing body straightening and repair procedures:

- DO NOT apply heat to any body part during straightening. This may compromise the internal structure and strength of high strength steel parts.
- Any part that has heat applied to it during straightening MUST be replaced with a new part.
- Ignoring these instructions may significantly reduce occupant protection in any subsequent collision.

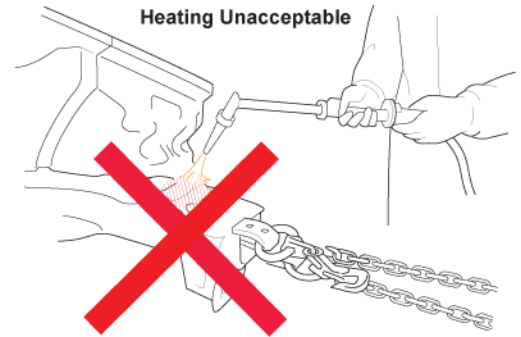

SECTIONING (CUT AND JOINT) GUIDELINES

Because of body structure improvements for collision safety and rigidity, the materials, steel thickness, and internal reinforcements have become very specific.

Follow these guidelines to avoid an unsafe repair:

- Avoid sectioning (cut and joint) except for outer panels and floor panels unless a specific procedure is provided in the body repair manual.
- Replace body structural components as assemblies that match the replacement parts configuration.

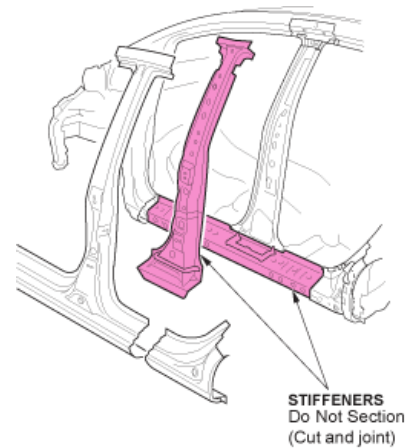

BLIND SPOT INFORMATION (BSI) SYSTEM

Touring Elite models equipped with this system can be identified by this BSI Alert Indicator, located on both front doors near the outside door mirrors.

- The system uses two radar units mounted on each side of the vehicle under the rear bumper.
- The system may malfunction and set DTCs because of damage, improper repairs, or excessive foreign material on any of the following:
 - Rear bumper
 - Outer side panels
 - Radar unit mounting locations

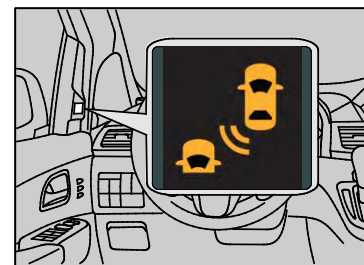

BSI Alert Indicator

- Several checks and inspections must be done during repairs to the radar unit mounting area. Procedures to check the BSI radar unit mounting area can be found:
 - Body repair manual "Rear Side Outer Panel Installation"
 - Service manual "BSI radar unit mounting area check"
- If the mounting area check is not done, a Honda dealer may not be able to properly aim the radar units.

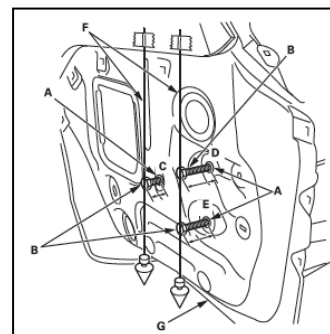

Left Rear of Vehicle Behind Bumper

Welding Precautions and Information

REPAIRING 1,500 MPa STEEL PARTS

Observe these precautions when repairing 1,500 MPa steel parts:

- NEVER attempt to straighten damaged 1,500 MPa steel parts because they may crack.
- 1,500 MPa steel parts MUST be replaced at factory seams using squeeze-type resistance spot welding (STRSW).
- MIG brazed joints should be used ONLY in locations not accessible by a spot welder.
- To assure adequate weld tensile strength, always set the spot welder to the specifications provided in the body repair manual.

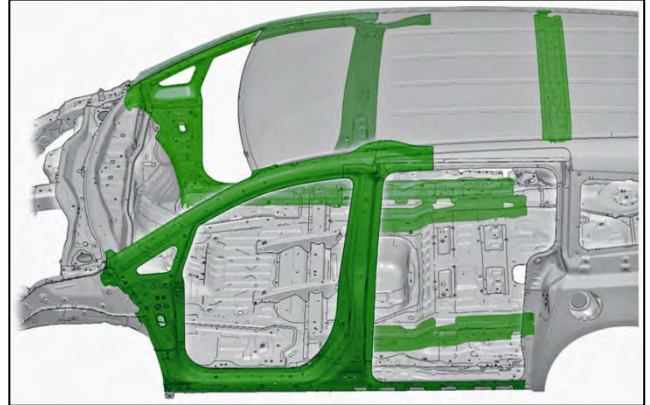

Important Information

Parts made of Ultra High Strength Steel (UHSS/1,500MPa/ USIBOR, Hot Stamp) must be installed as a complete part. No sectioning allowed. Ultra High Strength Steel requires special welding equipment, procedures, and settings. See the welding section of the appropriate body repair manual. Failure to use the proper equipment or follow the proper procedures can result in an unsafe repair.

- NEVER perform MAG welding on 1,500 MPa steel. The heat generated during welding will significantly reduce the strength and structural integrity of 1,500 MPa steel parts.
- This photo shows tensile strength test results of welded 1,500 MPa steel. The 1,500 MPa steel fractured first, because the welding heat reduced its strength to far below 590 MPa.
- For more information, refer to “Hot Stamp (1,500 MPa) Parts Welding Specifications” in the body repair manual.

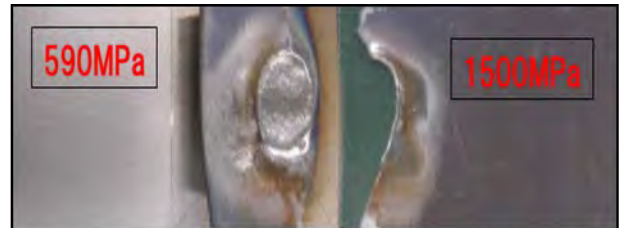

Tensile Test Results of Welded 1,500 MPa Steel

MIG BRAZING GUIDELINES FOR 1,500 MPa STEEL PARTS

Refer to the body repair manual for complete information:

- MIG brazed joint locations are specified in the body repair manual.
- A single or double hole MIG braze may be specified in the body repair manual depending on the tensile strength of the parts being joined.
- The size and number of holes are critical to achieving adequate joint strength.
- A pulsed MIG welder MUST be used. Refer to the equipment manufacturer's instructions for welder voltage and current set-up.
- Photos at right show the difference in results between pulsed and non-pulsed MIG brazing.

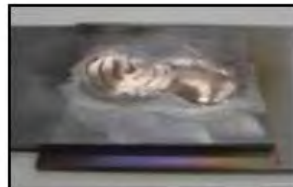

Pulsed MIG (OK)



w/o Pulsed MIG (Bad)



MAG WELDING SPECIFICATIONS FOR 590-980 MPa HIGH-STRENGTH STEEL PARTS

NOTE: In this publication and the body repair manuals, gas metal arc welding (GMAW) is referred to by its subtypes depending on the welding/brazing requirements:

- **MIG welding/brazing** = Metal inert gas welding or brazing where 100% argon (Ar) shielding gas is used. Argon is inert and does not react with the molten weld pool or brazing operation.
- **MAG welding** = Metal active gas welding where the shielding gas being used contains a mixture of 80% argon (Ar) and 20% carbon dioxide (CO₂). It is considered active because the CO₂ undergoes a limited reaction with the molten weld pool.

The body repair manual specifies the weld types and locations for each body panel:

- The welding wire used must have a tensile strength equal to, or greater than, the lowest tensile strength of the parts being welded. This conversion chart shows the relationship of steel tensile strength (MPa) to the minimum welding wire tensile strength (ksi).
- Typical ER70S MIG wire has a minimum tensile strength of 70 ksi (483 MPa). It can be used when welding up to 440 MPa steel parts. Refer to the diagrams shown below:

Important Information

Parts made of High Strength Steel (590-980 MPa) must be installed as a complete part. No sectioning is allowed unless a procedure is provided in the body repair manual. This high-strength steel requires special welding equipment, procedures and settings. See the welding section of the appropriate body repair manual. Failure to use the proper equipment or follow the proper procedures can result in an unsafe repair.

Steel Tensile (MPa)	Wire Tensile (ksi)
590	≥86
780	≥113
980	≥142

(1,000 psi = 1 ksi)

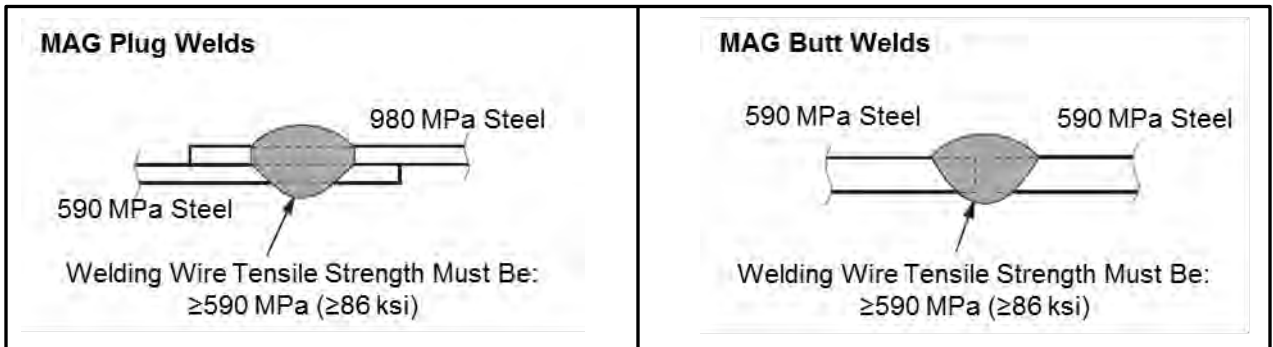

MAG PLUG WELDING GUIDELINES

- MAG plug welding may be done when joining body components to 590-980 MPa steel parts.
- Follow the recommendations described in the body repair manual section “MAG welding specifications for high-strength steel parts 590 MPa and higher.”

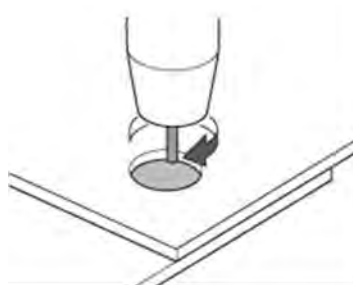

MAG Plug Welding

MAG BUTT WELDING GUIDELINES

- MAG butt welding may be done only on steel parts with a tensile strength of 590 MPa and lower.
- Welding speed is critical to achieve the correct weld strength and minimize the heat affected zone (HAZ).
- Follow the recommendations described in the body repair manual section “MAG welding specifications for high-strength steel parts 590 MPa and higher.”

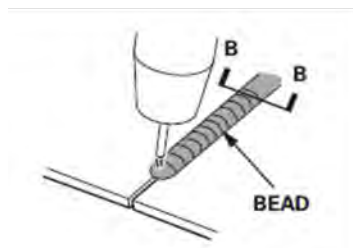

MAG Butt Welding

Airbag System Components and Repairs

AIRBAG SYSTEM COMPONENTS

The airbag system in this vehicle includes the following components that may deploy in a collision:

1. Driver and front passenger seat belt tensioners (may deploy independently from any airbags).
2. Driver and front passenger SRS airbags.
3. Side airbags mounted in the outer driver and front passenger seat-backs.
4. Left-and right-side curtain airbags mounted above the side windows under the headliner.

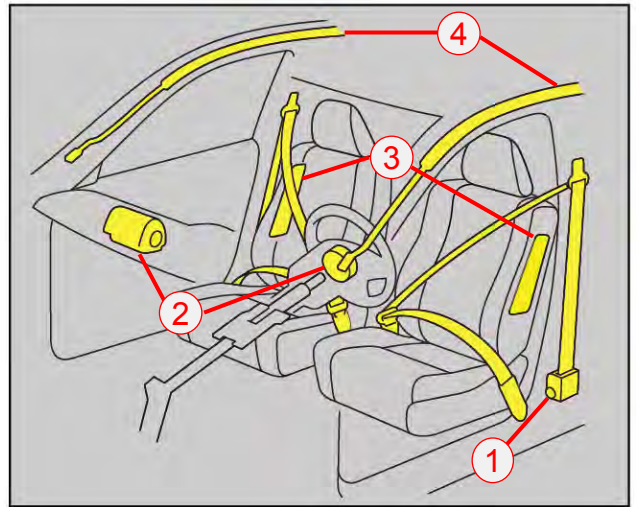

SMARTVENT™ SIDE AIRBAGS

Beginning with the 2014 model year, this vehicle is equipped with new SmartVent side airbag construction:

- This airbag design helps mitigate the risk of excessive airbag deployment force and risk of injury to smaller front passenger seat occupants.
- Eliminates the need for the Occupant Position Detection System (OPDS) sensor located in the front passenger's seatback.

As with all side airbags, the following service precautions apply:

- Special seat covers and/or breakaway thread are used to ensure proper deployment path.
- Damaged front seat covers should be replaced, not repaired.
- Do not install non-factory seat covers, because they may alter the airbag's intended deployment path.

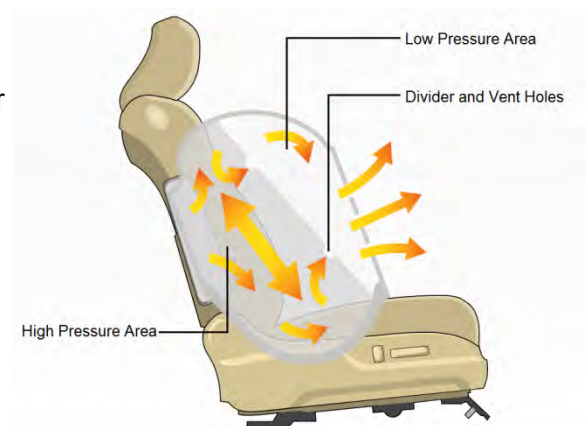

SmartVent Side Airbag

AIRBAG SYSTEM REPAIRS REQUIRED AFTER DEPLOYMENT

To restore proper function and allow DTCs to be cleared, the airbag system **MUST** be repaired as specified in the service manual. Refer to "Component Replacement/Inspection After Deployment" for complete information.

- **DO NOT** install used, refurbished, or modified airbag system parts!
- When making airbag system repairs, only use new genuine replacement parts, which are manufactured to the same standards and quality as the original parts.
- To ensure the correct replacement airbag system parts are installed, provide the vehicle's VIN when ordering parts. Compare the part numbers on the new and removed parts to make sure they match.

AIRBAG SYSTEM INDICATORS

There are three indicators used for the airbag system:

Supplemental Restraint System (SRS) Indicator

When you turn the vehicle to the ON mode, this indicator should come on and then turn off after about 6 seconds.

- If the SRS indicator does not go off, or does not come on at all, there is a problem with the system.
- DTCs must be read and cleared using the HDS (or equivalent) scan tool. Contact a Honda dealer for assistance if necessary.
- If a vehicle is sent to the dealer for airbag system repair or troubleshooting, include a copy of the repair estimate with part numbers and the source for any replaced airbag system parts.



SRS Indicator

Passenger Airbag OFF Indicator

The indicator comes on to alert you that the passenger's front airbag has been turned off.

- This occurs when the front passenger's weight sensors detect 65 lb. (29 kg) or less, the weight of an infant or small child, on the seat.
- If the indicator comes on with no front passenger and no objects on the seat, or with an adult occupying the seat, something may be interfering with the seat weight sensors, or there may be a problem with the system. Refer to "SRS Symptom Troubleshooting" in the service manual, or contact a Honda dealer for assistance if necessary.

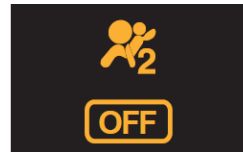

Passenger Airbag OFF Indicator

Side Airbag OFF Indicator (2011-13 Models Only)

This indicator comes on when the OPDS sensor detects that the front passenger side airbag needs to be shut off for safety:

- This may occur because the passenger is too small to be sitting in the front seat, is slouching or not sitting upright, or has leaned into the airbag's deployment path.
- This light is not used to indicate problems with the OPDS or airbag system.
- This light is not used on 2014 and later models because the OPDS sensor is not required when SmartVent™ side airbag construction is applied.



Side Airbag OFF Indicator

AIRBAG SYSTEM ELECTRICAL REPAIRS

Except when doing electrical inspections that require battery power, always turn the vehicle to the OFF (LOCK) mode, disconnect the negative battery cable, then wait at least 3 minutes before starting work.

- For easier identification, electrical connectors that contain only airbag system wiring are yellow in color.
- Many harnesses that contain primarily airbag wiring are also wrapped in yellow tape.
- Airbag system wiring that runs in a common harness, such as a floor harness, is generally not marked.
- NEVER attempt to modify, splice, or repair airbag system wiring. If airbag system wiring is damaged, replace the wiring harness(es).

NOTE: Refer to the service manual for complete restraint system operation, diagnostic, and repair information.



Electrical Repair Information

TIRE PRESSURE MONITORING SYSTEM (TPMS)

This vehicle is equipped with an initiator-less type TPMS.

- The low tire pressure indicator comes on if the air pressure is significantly low in one or more tires.
- Cold weather, the use of tire sealants, or installing (non-TPMS type) wheels, including the compact spare tire, may also cause the indicator to come on.
- The TPMS, or low tire pressure/TPMS, indicator will stay on and the system will set DTCs if all four tire pressure sensor IDs aren't memorized by the TPMS control unit after you:
 - Substitute a known-good wheel with tire pressure sensor.
 - Replace a tire pressure sensor
 - Replace the TPMS control unit
- Refer to "Memorizing a Tire Pressure Sensor ID" in the service manual for complete information.
- A TPMS trigger tool, such as the ATEQ VT55, and an HDS (or equivalent) scan tool are required to do the memorization procedure. Contact a Honda dealer for assistance if necessary.
- NOTE: The system indicators used vary depending on whether the vehicle has an information display or a multi-information display.

Indicators - Models With Information Display



Low Tire Pressure Indicator



TPMS Indicator

Indicator - Models With Multi-Information Display



Low Tire Pressure/TPMS Indicator

POWER SLIDING DOOR & TAILGATE INFORMATION

Power Sliding Door Information

All trim levels except LX are equipped with dual power sliding doors:

- A number of electrical and mechanical components must work in synchronization with each other in order for the doors to open and close properly.
- If the power sliding door control unit has lost power for any reason, or after replacing a power sliding door component, the doors must be "re-homed" before they will work properly.
- Refer to "Resetting the Power Sliding Door Control Unit" in the service manual for complete information.

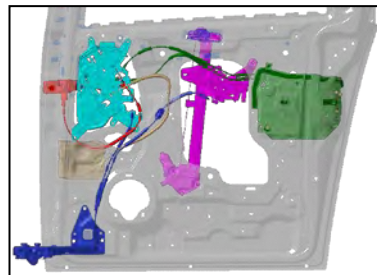

View Inside RH Sliding Door

Power Sliding Door Components

Power Tailgate Information

EX-L, Touring, and Touring Elite models are also equipped with a power tailgate:

- The power tailgate will not be able to open or close automatically until it is reset when:
 - The battery is disconnected, or the No. B16 (10 A) fuse in the under-hood fuse/relay box is removed while the power tailgate is operating.
 - Certain power tailgate components have been replaced.
- Refer to "Resetting the Power Tailgate Control Unit" in the service manual for complete information.

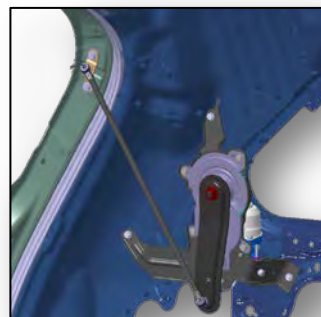

View Inside LR 1/4 Panel Area

Power Tailgate Actuator

SYSTEMS THAT MAY REQUIRE DEALER ASSISTANCE WITH AIMING

Beginning with the 2014 model year, some models may be equipped with one or more of the following systems that require aiming after collision repairs. Special tools are required to complete the aiming procedures. Contact a Honda dealer for assistance if necessary.

LaneWatch™:

LaneWatch uses a camera and the center display to help drivers recognize objects in the blind spot of the passenger side door mirror.

The LaneWatch camera must be aimed after one or more of the following procedures are done:

- LaneWatch camera removal or replacement
- Door mirror removal or replacement
- Door panel removal or replacement
- Door panel body repair

LaneWatch does not set DTCs. Troubleshooting and camera aiming are done using the navigation system or center display self-diagnostics. LaneWatch doesn't use an indicator to inform the driver of a malfunction.



LaneWatch Camera

Forward Collision Warning and Lane Departure Warning (FCW/LDW):

The FCW/LDW camera must be re-aimed if:

- The FCW/LDW camera unit is removed or replaced
- The windshield is removed or replaced

If the aiming is incomplete, the FCW and LDW indicators come on and/or blink.



ELECTRICAL PIGTAIL AND CONNECTOR REPAIR

- Disconnect the vehicle's battery before doing any welding or electrical repairs, Refer to "12 Volt Battery Terminal Disconnection and Reconnection" in the service or body repair manuals for more information.
- Certain front and rear electrical connectors subject to collision damage may be repaired using pigtails and connectors listed in the ELECTRICAL CONNECTORS illustrations in the parts catalog (example shown here).
- Pigtails attach to the vehicle wiring using special crimp-and-seal terminal joints. After crimping, the joints are heated using a heat gun to seal out the environment.
- Repair pigtails come in a limited range of colors that usually don't match the vehicle's wiring. Pay close attention during repairs to ensure correct locations.
- Vehicle wiring schematics service information can be found in the Electrical Wiring Diagrams (EWD).
- If wiring is damaged and a repair pigtail or connector is not available, replace the affected harness.
- NEVER attempt to modify, splice, or repair airbag system wiring.

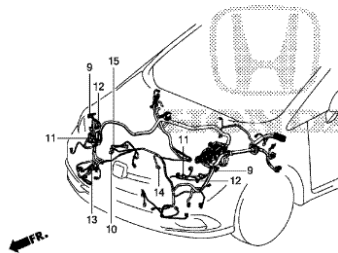

Part No.	CONNECTOR		SIZE	PIG TAIL	TERMINAL JOINT
	ILLUSTRATION	LOCATION			
9		FR. TURN	0.5	2	16
10		HORN	0.5	5	16
11		HEADLIGHT (HIGH)	1.25	4	17
12		HEADLIGHT (LOW)	0.5	3	16
13		WASHER MOTOR	1.25	4	17
14		RADIATOR FAN MOTOR	1.25	6	17
15		CONDENSER FAN MOTOR	2.0	7	18
			1.25	8	17

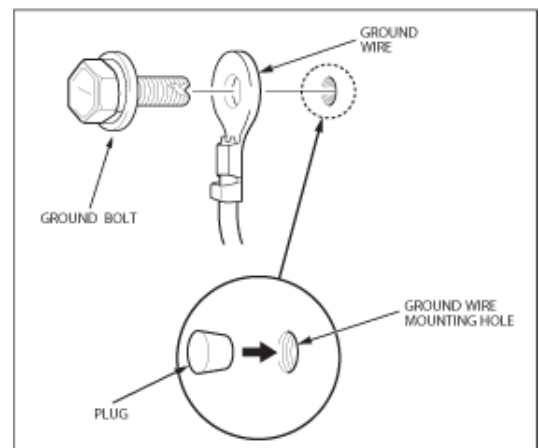

ELECTRICAL GROUND WIRE PROTECTION

- Painting over electrical ground locations may cause electrical systems, such as Vehicle Stability Assist (VSA), to malfunction and set DTCs that may be difficult to diagnose.
- Protect the ground wire and the ground wire mounting hole threads with a bolt or silicone plug when priming or painting.